

## CONTENT

1.	Manufacturer	1
2.	General safety information's	1
3.	Purpose	2
4.	Product compliance	2
5.	Degree of protection and technical data	2
6.	Type	3
7.	Mounting and installation	4
8.	Dimension	5
9.	Inspection, maintenance, repair and overhaul	5
10.	Spare part and accessories	6
11.	Responsibility and authorization	7
12.	Storage and transport	7
13.	Manufacturer's warranty	7
14.	Marking	7

## 1. MANUFACTURER

TEP Ex d.o.o.  
Prilaz dr. Franje Tuđmana 6 HR-49210 ZABOK  
Tel: +385 49 222 900  
Web: [www.tepex.hr](http://www.tepex.hr)

## 2. GENERAL SAFETY INFORMATIONS



### WARNING!

The user manual contains basic information about the product. Mounting, installation, usage and maintenance should be carried out under this user manual to provide and ensure safe operation within the nominal characteristics. This user manual complement national Regulation and Standards. The responsible person shall ensure their implementation. Failure off implement this user manual can reduce explosion protection and endanger people, property and the environment. Any improper and illegal actions as well as non-compliance with the provisions of this user manual excludes all responsibility by manufacturer side.

#### Before installation/commissioning:

- Carefully read all instructions,
- Execute proper training of responsible personnel,
- Check that the contents of these instructions is fully understandable by the responsible personnel,
- Make sure that all the requirements and national Regulations as well as all special security measures are applied.

#### In lack of understanding:

- Contact the manufacturer.

#### During operation:

- Ensure that this user manual and other work instructions are available to the responsible staff at all times,
- Check the implementation of these instructions and all other safety user's instruction

### 3. PURPOSE

Explosion proof pendant lighting fitting / light switch, type PLFM ...- is intended for general lighting in industrial with potentially explosive atmosphere of gases, vapors and dust in zones 1, 2, 21, 22 in accordance with EN 60079-10-1 and EN 60079-10-2.

### 4. PRODUCT COMPLIANCE

Design of lighting fitting is accordance with the standard EN 60598-1 and all related standards.

The product is in compliance with Regulations concerning equipment and protective systems for use in potentially explosive atmosphere.

The product complies with the ATEX Directive 2014/34/EU and standards:

- EN IEC 60079-0:2018,
- EN 60079-1:2014,
- EN IEC 60079-7:2015/A1:2018,
- EN 60079-31:2014.



The product has been developed, manufactured and tested according to the existing state of technique accordance with the standards EN 9001, EN ISO 80079-34 and EN ISO 14001.

The product is in compliance with the LV Directive 2014/35/EU.

The product is in compliance with the RoHS Directive 2011/65/EU.

The product is in compliance with EMC Directive 2014/30/EU.

### 5. DEGREE OF PROTECTION AND DATA

Certificate:	FIDI 19 ATEX 0047
Category and explosion protection:	 0722  II 2G Ex db eb IIC T6-T3 Gb ili II 2G Ex db IIC T6-T3 Gb II 2D Ex tb IIIC T85°C – T155°C Db
Ambient temperature:	-20°C ≤ T <sub>a</sub> ≤ +40°C
Mechanical protection:	IP66, category 1
Resistance to shock:	IK 08
Class of protection:	I (PE - protective earthing)
Rated voltage:	-230 V (-10% / +6%) / 50 Hz - PLFM FLASH, PLFM LUXOMAT- . see Table of light sources
Rated power:	- see Table of light sources
Luminous flux	- see Table of light sources
Wiring:	- Radox 155 or Betatherm 155, IEC 60228:2005 IEC 60228:2005 class 5, 1,5mm <sup>2</sup>
Connection terminals inside housing / light switch:	- tree-pole plug and socket terminals for connection L + N + PE; 2,5mm <sup>2</sup> max, solid, stranded - four-pole plug and socket terminals for connection L + L' + N + PE; 2,5mm <sup>2</sup> max, solid, stranded
Connection terminals inside Ex eb / tb junction box / light switch:	- conductor terminals for connection of phase, neutral and protective conductor L + L' + N + PE; 2,5mm <sup>2</sup> single-wire, multi-wire - true wiring is also possible by connecting two conductors to the same terminal inside the Ex eb connection chamber, 2,5mm <sup>2</sup> max.
Ex eb / tb cable glands and plugs	- two Ex eb / tb SPU 25 cable glands ISO 25 II 2G Ex eb IIC Gb II 2D Ex tb IIIC Db for diameter cable Ø7-15 mm in accordance EN 62444 Certificate: FIDI 19 ATEX 0003X - two Ex eb / tb TEPEX plugs, II 2G Ex eb IIC Gb II 2D Ex tb IIIC Db in accordance EN 62444 Certificate: FIDI 19 ATEX 0003
Connection terminals inside Ex db eb/tb adapter ADP 23/1:	- terminals for connection L + N + PE; 2,5 mm <sup>2</sup> , - solid, stranded
Connection terminals inside Ex db eb/tb adapter ADP 24/1:	- terminals for connection L + N + PE; 2,5 mm <sup>2</sup> , - solid, stranded
Adapter ADP:	- type ADP 23/1, ADP 24/1, II 2G Ex db eb IIC Gb II 2D Ex tb IIIC Db, for cable Ø <sub>v</sub> 7-15 mm Certificate: FIDI 19 ATEX 0014X
Connection cable for direct entry via Ex db / tb cable entries:	- connection on tree-pole / four-pole plug inside housing for connection L + N + PE; 2,5mm <sup>2</sup> solid, stranded
Ex db / tb cable gland:	- ATEX certified II 2G / D Ex db / tb IP66 M20 cable gland

Tightening torque:	- screws of Ex eb terminal 0,8 Nm - screws of Ex e cover of junction box 0,8 Nm - pressure nut of cable gland 2,5 Nm
Ballast:	- 230V/50Hz 70/50W 1,00/0,76A $\lambda=0,37$ $t_w=130^\circ\text{C}$ $\Delta T=70/50\text{K}$ in accordance EN 61347, Vossloh Schwabe, GmbH
Light switch:	- Dasy 010-2 12V AC/DC - Dasy 010-2 24V AC/DC - Dasy 010-2 230V AC - Dasy 016-2 230V AC Manufacturer: Doepke GmbH, Germany All capacitors inside the light switch will be discharged within 5 min. below 0.02 mJ according to p. 6.3. EN IEC 60079-0: 2018
Lamp holder:	- E27, 250V, 4A, according to EN 60238:2004, Vossloh Schwabe, GmbH
Dimension:	- 339 x 208 x 130 mm – PLFM 100-, PLFM 100/1-, PLFM 100/2-, PLFM 100/3-, PLFM 20 LED-, PLFM FLASH-. - 380 x 208 x 130 mm – PLFM 70 HSE-.
Weight:	- 3,5 kg - PLFM 100-, PLFM 100/1-, PLFM 100/2-, PLFM 100-3-, PLFM FLASH-. - 4,5 kg - PLFM 20 LED-, PLFM 70 HSE-.
Mounting:	- allowed only vertical mounting – PLFM 100/1-. - allowed deviation from the vertical max. 30 ° - PLFM 100-, PLFM 100/2-, PLFM 100/3-, PLFM 20 LED-, PLFM FLASH-.

For versions with mounted Ex db eb adapter (PLFM ...- 2) there are specific conditions of use:

- the user must ensure adequate fastening of the cable outside the cable gland because the cable gland of the multi-core conductor insulator with a connection chamber has been tested with a lower pulling force in accordance with p. A.3.1.1 of EN IEC 60079-0,
- the device must be installed in places with a lower risk of impact because the multi-core conductive insulator with a connection chamber has been tested with a lower impact energy in accordance with EN IEC 60079-0.

Threaded joints:

- M125x1,5 - 6H / 6g, medium tolerance according to ISO 965-3, thread DIN 13 T.24, 11 full threads,
- M20x1,5 - 6H / 6g, medium tolerance according to ISO 965-3, thread DIN 13 T.24, 7 full threads.

For luminaires type PLFM 100 / 1-3 (versions with direct entry) it is necessary to use a cable with a temperature resistance not less than 90 ° C. For luminaires type PLFM 70 HSE-3 (version with direct introduction) it is necessary to use a cable with a temperature resistance not less than 140 ° C.

## 6. TYPE

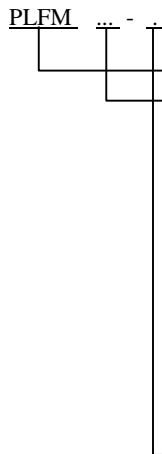

### basic type code

#### maximal wattage and type of sources:

- 100 - A incandescent lamp 100W max,  
- A ECO halogen lamp 105W max,  
- QT halogen lamp 100W max.
- 100/1 - LME mixed discharge lamp 100W max.
- 100/2 - TC-SB compact fluorescent lamp 23W max.
- 100/3 - LED BULB lamp 15W max.
- 20 LED - LED MODUL special 20W max.
- FLASH - XENON MODUL special 5W max.
- 70 HSE - HSE-I high pressure sodium discharge lamp 70W,  
- HSE-I high pressure sodium discharge lamp 50W.
- LUXOMAT 10 – light switch 10A,
- LUXOMAT 16 – light switch 16A.

#### Type of entries:

- 1 – indirect entry – type with Ex eb junction box,
- 2 – indirect entry – type with Ex db adapter ADP 23/1,
- 3 – direct entry – type with Ex db cable gland.

Table of light sources:

Model code	Max. wattage	LBT marking	Nominal voltage	Luminous flux	Lamp holder	Temp. class (gas)		OSRAM type	PHILIPS type	Another supplier
						T <sub>a</sub> =40°C	T <sub>0</sub> MAX (dust) T <sub>a</sub> =40°C			
PLFM 100 - .	100 W	A	230V	1340 lm	E27	T4	130°C	-		GE Lighting - Rough Service GLS - Clear
	116 W Osram 105 W Philips	A ECO	230 V	2135 lm Osram 1980 lm Philips	E27	T4	130°C	Halogen Classic A ECO	EcoClassic A - shape	-
	100 W	QT	230 V	1800 lm Osram	E27	T4	130°C	Halolux Ceram Eco	-	-
PLFM 100/1 - .	100 W	LME	230 V, 50 Hz	1100 lm	E27	T3	155°C	-	ML Mixed Light lamps	-
PLFM 100/2 - .	22 W Osram 23 W Philips	TC-SB	230 V, 50 Hz	1440 lm	E27	T6	80°C	Osram Deluxe-Intelligent Longlife	Master PL - Electronic	-
PLFM 100/3 - .	12 W Osram 13 W Philips	LED	230 V, 50 Hz	810 lm Osram 1055 lm Philips	E27	T6	80°C	Parathorn Ledotron Classic A	Master LED bulb	-
PLFM 20 LED - .	20 W	LED modul	230 V, 50 Hz	1300 lm	-	T6	80°C	-	-	Vossloh LED LR 42
PLFM FLASH - .	5 W	XENON	10-100 V DC	4J/90Hz	-	T6	80°C	-	-	RS Components - Miniature Xenon beacons
			110 V AC							
			230 V AC							
PLFM 70 HSE - .	70 W	HSE	230 V, 50 Hz	5900 lm Osram 5600 lm Philips	E27	T4	130°C	Vialox NAV-E 70W/I	SON 70W I E27 CO 1CT	-
	50W	HSE	230 V, 50 Hz	3600 lm Osram 3500 lm Osram	E27	T4	130°C	Vialox NAV-E 50W/I	SON 50W I E27 CO 1CT	-
PLFM LUXOMAT 10 - .	-	-	12 V AC/DC 24 V AC/DC 230 V AC	-	-	T6	85°C	-	-	Doepke DAS Y 010
PLFM LUXOMAT 16 - .	-	-	230 V AC	-	-	T6	85°C	-	-	Doepke DAS Y 016

## 7. MOUNTING AND INSTALLATION

Mounting of the lamp:

- With vertical suspension on the bolt with ring bolt head M8 witch is twisted in the housing and further blocked from self-loosening

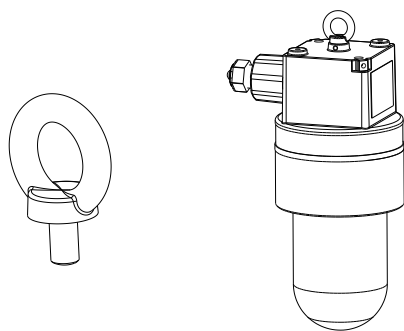

- Mounting on the tube 2" and blocking it with two M10 screws

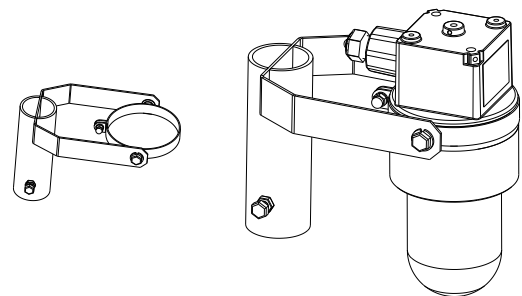

Before opening the housing, unscrewing the assembly of the protective glass, mechanical release should be carried out by unscrewing the blocking screws M4x14 ISO 4027 in the framework of the glass. Removing the lamps is only allowed in the not energized state. Not energized state must be ensured by switching of the master switch. It is recommended only to install light sources listed in the table of light sources.

Electrical connection is made by connecting the power cable to the terminal connection terminals L - phase conductor, N - neutral, PE - protective earth. For direct entry of cable, electrical connection is made by connecting the power cable to the plug.

Type PLFM 70 HSE is factory wired for High pressure sodium source of 70W and connection diagram is shown in the following figure:

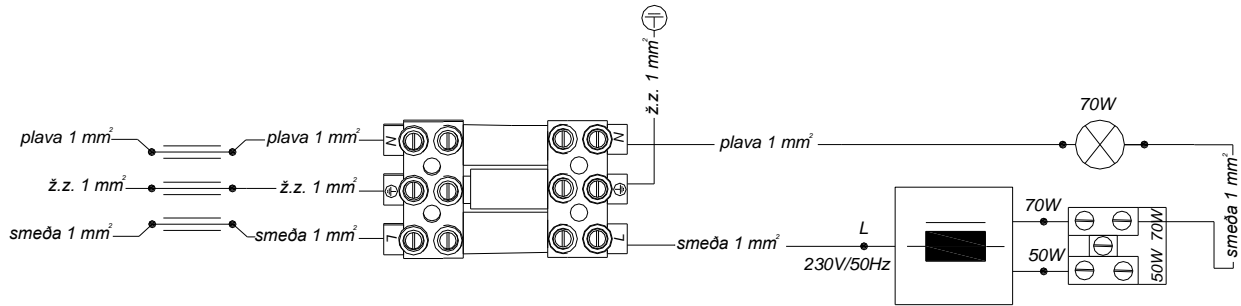

If the user wants to install High pressure sodium source of 50W, it is necessary that the brown phase conductor which is connected to the lampholder E27 is reconnected to the two-pole terminal from 70W to 50W. After each opening lamp protective fitting must be protected with "Baplex" protective agents (manufacturer's recommendation).

Wiring diagram PLFM LUXOMAT:

Adapter

ADP 24/1

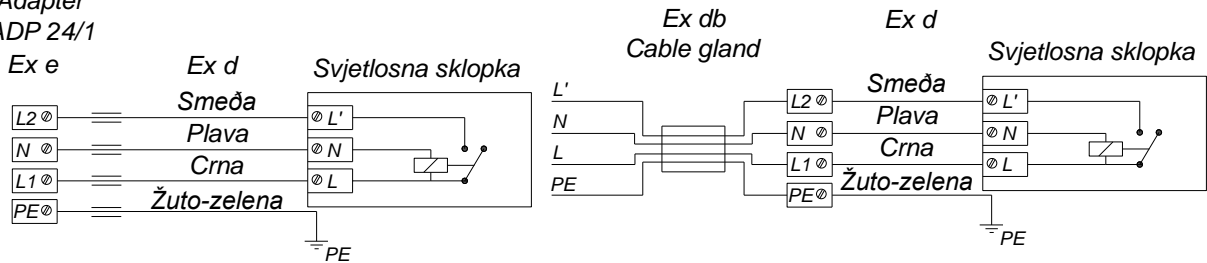

## 8. DIMENSIONS

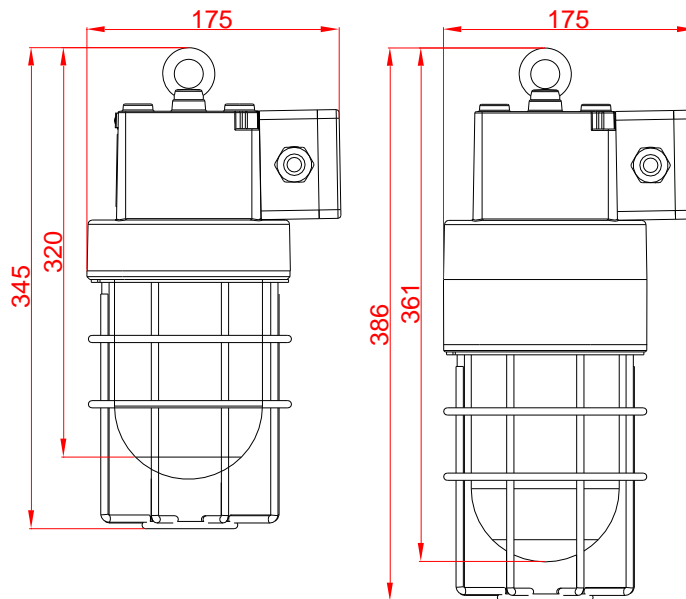









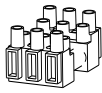

## 9. INSPECTION, MAINTENANCE, REPAIR AND OVERHAUL

Inspections are carried out in accordance with IEC 60079-17:2014, general and special conditions of manufacturer and users Regulations and includes supervision of parts on which the explosion protection depends, especially:

- that the housing, all part of housing, replacement glass and gaskets without rupture and damage,
- that the housing completely closed with replacement glass compound and that mechanical blockage against self opening is done,
- that the cable gland, plug, adapter, pressure nut of cable gland, screws cover of junction box and connection terminal are fastened with nominal torque.

All the repairs are performed by the manufacturer or the manufacturer's authorized personal and the original parts must be provided according to the product documentation, all in accordance with EN 60079-19.  
 If repair or any other procedure are performed on the product by unauthorized person, all producer responsibility for the product and the warranty and the manufacturer's declaration of conformity becomes invalid.

## 10. SPARE PART AND ACCESSORIES

SKETCH	DESCRIPTION	CODE	SKETCH	DESCRIPTION	CODE
	Replacement glass PLFM	PLFM 10 - 120		plug and socket terminals	PLFM 10-180
	Gasket PLFM	PLFM 10 - 140		Adapter ADP 23-1	PLFM 20 - 110
	Heat sink SET PLFM	PLFM 10-180		Ex e cable gland SPU 25	SPU 25
	Lamp holder PLFM	PLFM 10 - 150		Ex eb plug SPC 25	SPC 25
	Ballast SET PLFM	PLFM 10-170		Ex db cable gland	-
	Light switch 10/16A	Doepke Dasy 10 Doepke Dasy 16			

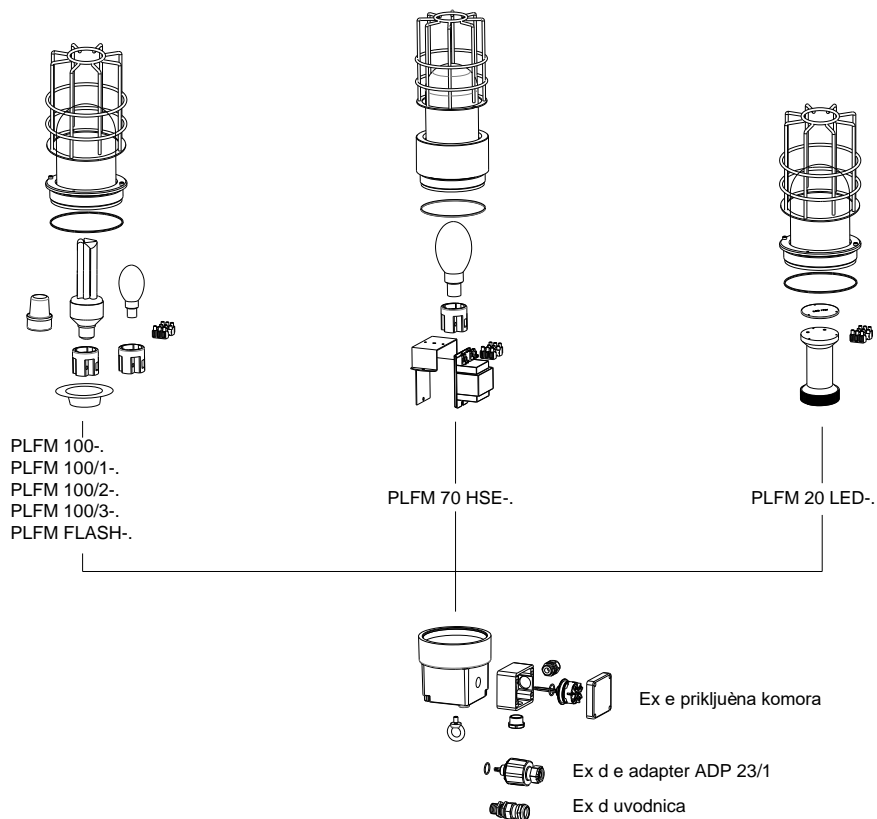

## 11. RESPONSIBILITY AND AUTHORIZATION

---

This instruction is the basic information about the product. It is completed by the corresponding national laws and regulations.

Production, use, certification and supervision are determined at the national level:

- a) Regulations concerning equipment and protective systems intended for use in potentially explosive atmospheres EU directive ATEX 2014/34/EU
- b) Regulations on minimum requirements for safety and health protection of workers and technical inspection of facilities, equipment, installations and equipment in hazardous areas EU directive 1999/92/EC (ATEX 137).

The responsible person shall ensure their implementation at the working facility.

## 12. STORAGE AND TRANSPORT

---

Transportation and warehousing of the lamps is only allowed in the original packaging, as outlined in a cardboard box.

## 13. MANUFACTURER'S WARRANTY

---

The manufacturer provides a warranty on the product for a period of one year under the provisions of this user manual and the law on obligations. This statement has the force of Warranty sheet.

## 14. MARKING

---

Explosion-protected pendant lighting fitting , type PLFM ... - . - . is labeled with:

- warning plate on housing, type PLFM 100-, PLFM 100/2-, PLFM 100/3-, PLFM 20 LED-, PLFM FLASH-, PLFM 70 HSE-1, PLFM 70 HSE-2, PLFM LUXOMAT ..-:

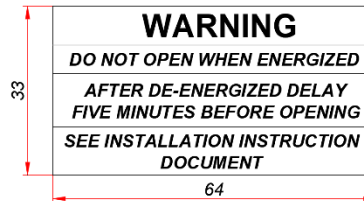

- warning plate on housing, type PLFM 100/1-1, PLFM 100/1-2:

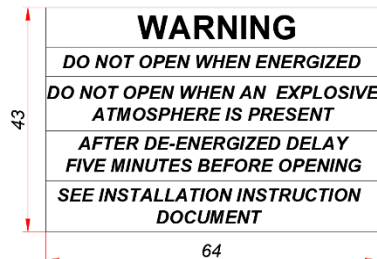

- warning plate on housing, type PLFM 100/1-3:

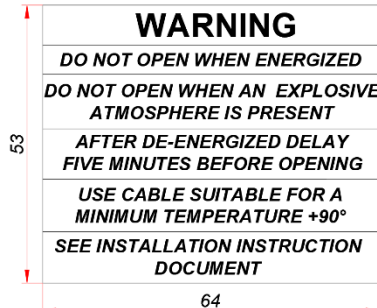

- natpisnom pločicom na kućištu, tip PLFM 70 HSE-3:

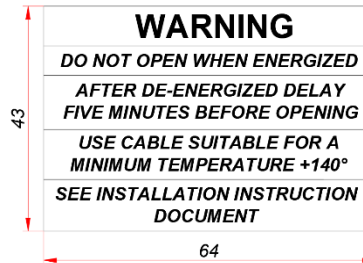

- marking plate with technical data on housing and inside housing:

